



Operating Instructions

CHARGERY BM16LP v3.0

Microprocessor controlled high performance **Battery Monitor**
For 3S~16S LiPoly battery pack.



Chargery Power Co., Ltd.

Head Office

Add: Chuangye Road, Nanshan Shenzhen, 518054, China.

Zip code: 518054

Tel: +86 755 2643 6165

Fax: +86 755 2641 2865

Email: admin@chargery.com.cn

Web: www.chargery.com

Thanks for your purchasing the Battery saver, please read the manual carefully before using.

Chargery Battery Saver BM16LP is for 3S ~ 16S LiPolymer battery applied to E-bike, E-scooter etc., High light red LED and loud beepers (85Db) make sure battery operation safety. The unit is with TFT color LCD display battery voltage, cell voltage, 2 battery temperature, and battery SOC (State of Charge). You can setup over discharge warning cell voltage, over charge warning voltage, the highest battery temperature and the lowest battery gauge for warning.

During battery discharge, if any cell voltage under setup value, or battery temperature over setup or battery gauge under setup, the BM16LP can sound and LED flash alternately prevent any cell from over discharged.

During battery charge, if any cell voltage over setup value, or battery temperature over setup, the BM16LP can sound and LED flash alternately prevent any cell from over charged.

In any case, when cell voltage difference is over setup value, the unit can alarm.

When stop driving your bike or scooter, you can check the lowest cell voltage, so you can find the worst cell---the lowest voltage cell.

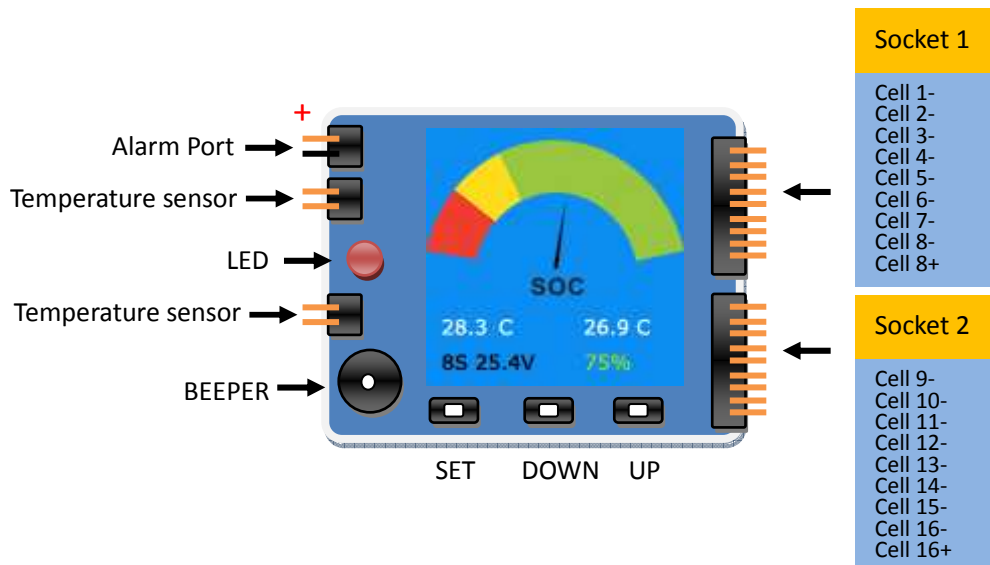

New features

- BM16LP can indicate battery SOC or called battery gauge similar with car dashboard. Cell count, battery pack voltage and battery gauge (%) is displayed simultaneously.
- BM16LP will record the lowest voltage of each cell during discharge, after you stop driving your bike, scooter etc., you can press **UP** or **DOWN** button to display these voltages (**cell number background color is green, and the lowest cell voltage displayed in RED text**), press the button again display real voltage.
- Add an alarm port to drive relay etc.
- Beeper sound and LED flash alarm alternately while any cell over charged or over discharged or out of the setup range including temperature SOC, difference of cell voltage.
- Two temperature sensors monitor battery temperature during charge or discharge.
- At any time, you can press **SET** button shortly turn off the display and press again resume.
- While alarming, press **SET** button shortly turn off alarm.

Operating guideline

1. Connect the battery to BM16LP, keep the polarity correct. The detailed connection diagram is as the following figure 1 and figure 2.
2. The unit will initialize the beeper and LED, beeper sounds once time, warning LED flash once time.
3. 2 seconds later, the BM16LP will display battery SOC (State Of Charge) as same as car dashboard., two battery temperatures, cell count, battery pack voltage, and battery gauge in digital percentage on the bottom line from left to right.

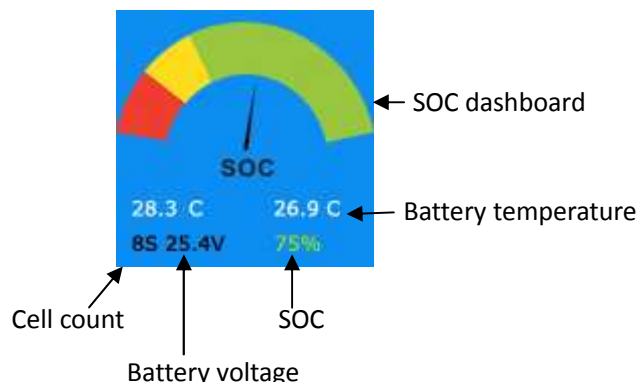

4. Press **UP** or **DOWN** button to check with each cell voltage and lowest voltage during driving.
5. Press **SET** button for 3 seconds enter into Program Setup menu.

In driving, BM16LP can alarm loudly and a RED LED flash alternately when any cell voltage under over discharge warning voltage till the cell voltage over the value.

If the cell voltage is still under warning voltage, the unit will beep and flash repeat for 20S.

The unit includes reverse polarity detection, and 2.54mm pin distance balance connector for all kinds of battery.

Connection Diagram

There are 2 sockets connecting to battery pack, socket 1 is for 3S~8S and socket 2 for 9S~16S battery.

1. One 3S to 8S battery can plug into the socket 1 directly, 6S connections as following.

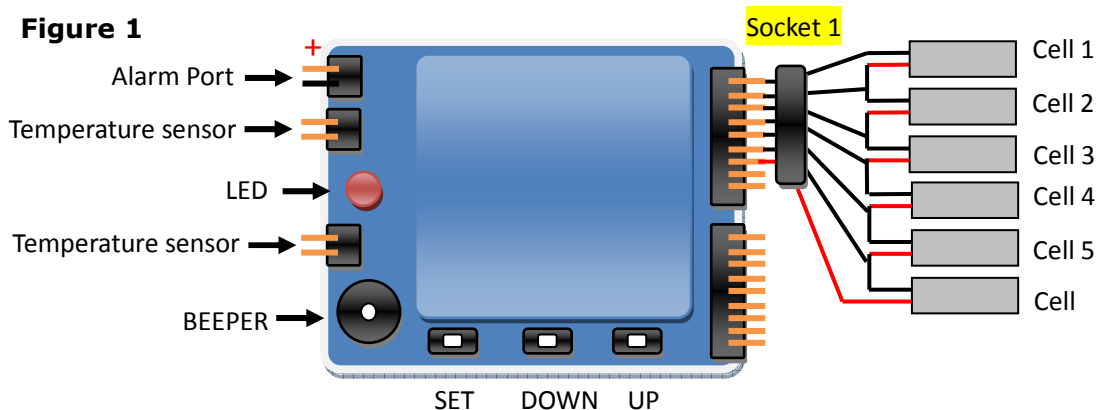

2. For two battery packs, connect them in series first and then plug battery 1# into socket 1, and

battery 2# into socket 2 separately. Take one 8S battery and one 4S sample as following:

Figure 2

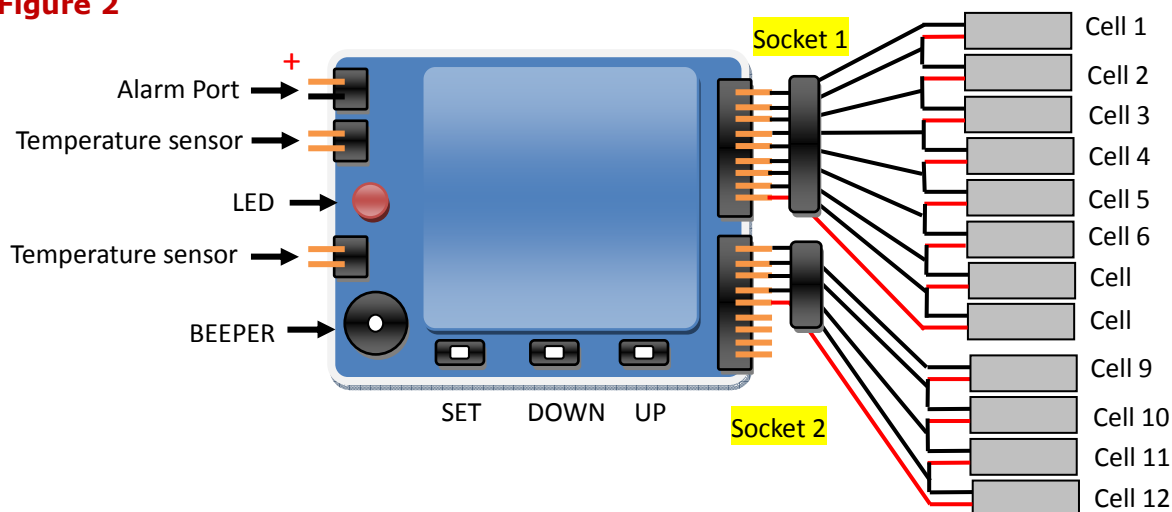

Specifications:

- Battery range: 3S-16S LiPolymer battery pack
- Over discharge warning cell voltage: **2.80~4.20V** step 0.05V, default 3.00V
- Over charge warning voltage: **3.90~4.30V** per cell, step 0.05V, default 4.25V
- Over cell voltage difference warning voltage: **0.010~0.500V** per cell, step 0.005V, default 0.050V
- Over temperature warning: **30~80°C** step 1°C, **default 50°C**
- Under battery gauge (SOC) warning: **5~90%** step 1%, **default 30%**
- Delay time when start to warning: **2S**
- Warning time: **20S** per period
- Accurate scope of the cell voltage: **-5mV/+5mV**
- Cell voltage display range: 0.50V~4.99V, NO display when under 0.50V
- Temperature display range: 0.0°C~99.9°C,
 - Display 0.0 when under 0.0°C
 - Display 99.9 when over 100°C
- SOC indicator:
 - RED area @ 0~15% of SOC
 - YELLOW area @ 16~35% of SOC
 - GREEN area @ 36~100% of SOC
- Pins distance: 2.54mm
- Size: 70*65*11 (L*W*T, mm)
- Weight: 30g
- Warning LED: 11000mCd, @ 2.0V, 20mA
- Warning beeper: 85dB @ 12V, 25mA
- Package: transparent heat shrink tube or Customized AL alloy case



Program setup

Before driving your e-bike or e-scooter etc., you can set up many important parameters prevent your battery from over charge, over discharge, over difference of cell voltage, under battery gauge or over temperature.

1. Connect your battery to BM16LP
2. Press **SET** button for 3 seconds enter into Program Setup menu.
3. Press **UP** or **DOWN** button select the item, press **SET** shortly make the value flash, and press **UP** or **DOWN** change the value. Press **SET** button shortly confirm the change. After finish all setup, press **SET** for 3 seconds quit the setup menu.
4. When quit setup mode, the device will remember all parameters till next change.



NOTE: Please keep the default setup unless for special purpose.

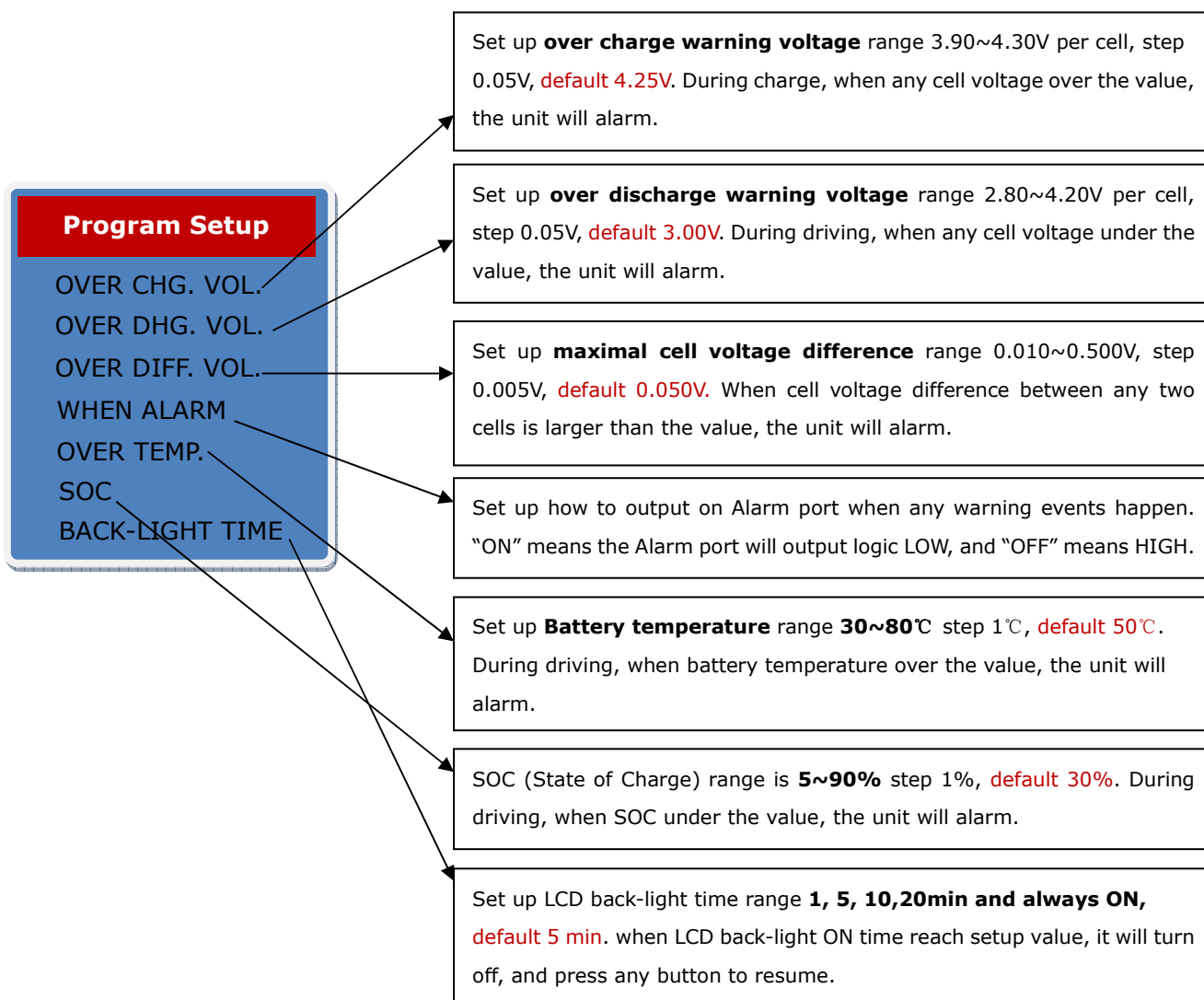

Alarm Remind

If the device detects the alarm events, including over charge, over discharge, over temperature and over difference voltage, it can do:

1. The buzzer beeps and LED flash.
2. You can press **UP** or **DOWN** button check the error information, as the following.



Error information

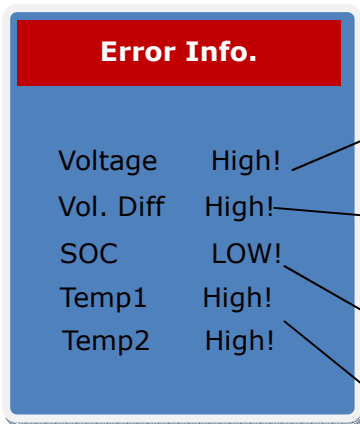

- Any cell voltage over setup during charge, display Voltage High!
Any cell voltage under setup during discharge, display Voltage Low!
- When cell voltage difference over setup during charge, discharge or storage, display Vol. Diff High!
- When battery pack SOC (State of Charge) under setup, display SOC Low!
- When battery temperature over setup, display Temp1 or Temp2 High!

3. At the same time Alarm port will output the presetting signal ON or OFF.
Alarm output port signal ON means the collector connected to Ground.
Alarm output port signal OFF means the collector open.

Warning:

Please attention to the port voltage and current limit when use (<30V, 1A)

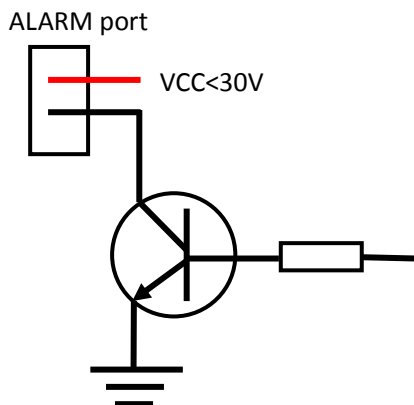



Warranty and Service

Chargery Power Co., Ltd. as manufacture of R/C model power warrants its charger and saver, monitor etc. to be free of defects in material and workmanship. This warranty is effective for 12 months from date of purchase. If within the warranty period the customer is not satisfied with the products performance resulting from a manufacturing defect, the accessory will be replaced or repaired.

Your selling dealer is your first point of contact for warranty issues. Return postage costs are the responsibility of the user in all cases. Please submit copy of original receipt with the return.

Damage due to physical shock (dropping on the floor, etc.), inappropriate power supply (unstable output voltage and insufficient power, etc.), water, moisture, and humidity are specifically NOT covered by warranty.



Chargery Power Co., LTD.

Chuangye Road, Nanshan Shenzhen, 518054, China.

Tel: 86 (0)755 26436165, fax: 86 (0) 755 26412865

Email: jasonwang3a@163.com

Homepage: www.chargery.com

